

Remote I/O

IS1+ Remote I/O Digital input-output module

For Zone 2 Ex n

9471/35-16-11 Art. No. 230225



- Sixteen channels can be used in pairs as inputs or outputs
- Inputs/outputs Ex ec with line fault monitoring and LED error and status indication for each channel
- Module in Zone 2, Cl. I, Div. 2 can be hot swapped

MY R. STAHL 9471B



The 9471/35 series digital input/output module for Zone 2, Cl. I, Div. 2 has 16 channels, which can be used in pairs for operation as inputs for contacts, NAMUR proximity sensors (EN 60947-5-6) and PNP proximity switches or as outputs for indicator lamps and low-power solenoid valves. Eight inputs can be used for frequencies of up to 20 kHz, and four can be used for detecting the direction of rotation.

All inputs/outputs are short-circuit proof and galvanically separated from the system.

Technical Data

Explosion Protection

Application range (Zones)	2
Ex interface zone	2
IECEX gas certificate	IECEX DEK 16.0010X
IECEX gas explosion protection	Ex ec ic [ia Ga] IIC T4 Gc
ATEX gas certificate	DEKRA 16 ATEX 0016 X
ATEX gas explosion protection	Ex II 3 (1) G Ex ec ic [ia Ga] IIC T4 Gc
FMus certificate	FM17US0332X
cFM certificate	FM16CA0134X
Marking cFMus	NI, Class I, Div. 2, Groups A,B,C,D; Class I, Zone 2, AEx/Ex ec ic Group IIC T4 Gc Ta = -40°C ... +75°C See Doc. 9471 6 031 001 1
Certificates	ATEX (DEK), Canada (FM), China (NEPSI), IECEX (DEK), India (PESO), Korea (KTL), USA (FM)
Ship approval	ABS, BVIS, EU RO MR (DNV), KR, LR
Declaration of Conformity	ATEX (EUK), China (CCC)
Installation	Zone 2, Cl. I, Div. 2 and safe area
Further information	see respective certificate and operating instructions

Electrical Data

Number of channels	(adjustable parameters in pairs) 16 Ex ec inputs/outputs
Max. number of NAMUR inputs	16 (channels 0 to 15)
Max. number of 3-conductor PNP inputs	16 (channels 0 ... 15)
Max. number of binary outputs	16 (channels 0 to 15)

Remote I/O

IS1+ Remote I/O Digital input-output module

For Zone 2 Ex n

9471/35-16-11 Art. No. 230225



Electrical Data

Connection Ex ec/nA field signals (X1 and X2)	2 pluggable, black terminals, 24-pin, 1.5 mm ² , push-in design with lock (must be ordered separately) Single-wire connection - rigid 0.08 to 1.5 mm ² (AWG 28 to 16) - flexible with core end sleeves (without plastic sleeve) 0.25 to 1.5 mm ² - flexible with core end sleeves (with plastic sleeve) 0.25 to 0.5 mm ² - Stripping length min. 9 mm
---	--

Auxiliary Power

Power supply connection	BusRail types 9494
Auxiliary power version	Intrinsically safe Ex ia via BusRail
Behaviour during undervoltage	All outputs "OFF"
Current consumption	90 mA
Max. power consumption	2.2 W
Max. power dissipation	0.7 W

Galvanic Isolation

Test voltage for galvanic separation	Acc. to standard EN 60079-11
Auxiliary power/system components	≥ 1800 V AC
I/O channels/system components	≥ 1800 V AC
I/O channels / ground (PA)	≥ 1800 V AC

Input

Max. number of counter inputs	8 (channel 8 to 15)
Max. number of frequency inputs	8 (channel 8 to 15)
Binary input 1 signal type	2-conductor 24 V contacts 3-conductor PNP initiators
Min. binary input signal 1 ON	> 13 V
Max. binary input signal 1 OFF	< 5 V
Binary input 1 switching hysteresis	5%
Binary input 1 internal resistance	11 kΩ
Binary input 1 wire breakage detection	Input signal < 2 V
Binary input 1 short-circuit detection	Input signal ≤ 1.6 V
Binary input 2 signal type	NAMUR initiators (IEC 60947)
Min. binary input signal 2 ON	> 2.1 mA
Max. binary input signal 2 OFF	< 1.2 mA
Binary input 2 operating point	1.65 mA
Binary input 2 switching hysteresis	≥ 0.2 mA
Binary input 2 supply voltage	8 V ± 5%
Binary input 2 internal resistance	1 kΩ
Binary input 2 wire breakage detection	I < 100 μA
Binary input 2 short-circuit detection	R < 100 ohms
Binary input 3 signal type	Frequency input
Max. switching frequency binary input 3	NAMUR signal: 20 kHz (at frequencies > 1 kHz, the maximum conductor length is reduced, e.g. at 5 kHz to approx. 75 m) 3-conductor PNP proximity switches and 2-conductor 24 V contacts: ≤ 300 Hz (20 kHz only with push-pull encoder) Note: The inputs must be switched to +24 V and 0 V (see technical drawings).
Binary input 3 min. pulse width	25 μs
Binary input 4 signal type	Counter input

Remote I/O

IS1+ Remote I/O Digital input-output module

For Zone 2 Ex n

9471/35-16-11 Art. No. 230225



Input

Binary input 4 counting range	0 ... 65535				
Binary input 4 function	Forwards/backwards counter Frequency with direction				
Binary input 4 resolution	16 (unece.unit.BIT) 32 (unece.unit.BIT)				
Measuring range of binary input 3		0.1 to 600 Hz	1 Hz to 3 kHz*	1 Hz to 20 kHz	
	Measurement discrimination	0.01 Hz	0.05 Hz	0.5 Hz	
	Accuracy	0.1%	0.1%	0.1%	
	* Default				
Max. delay of binary input 3	Filter (adjustable parameters)	None	Small	Medium	Large
	Frequency				
	0.1 Hz ≤ f < 1 Hz	1/f + 1 ms	2/f	3/f	6/f
	1 Hz ≤ f < 10 Hz	1/f + 1 ms	4/f	9/f	18/f
	10 Hz ≤ f < 100 Hz	1/f + 1 ms	8/f	27/f	54/f
	100 Hz ≤ f < 1 kHz	1/f + 1 ms	16/f	81/f	162/f
	1 kHz ≤ f < 1960 Hz	1.5 ms	32/f	243/f	486/f
	1960 Hz ≤ f < 10 kHz	1.5 ms	16.5 ms	124 ms	248 ms
	10 kHz ≤ f < 20 kHz	1.5 ms	33 ms	372 ms	744 ms
f ≥ 20 kHz	1.5 ms	66 ms	372 ms	744 ms	

Output

Signal type binary output	2-conductor (6 V/2 mA)
Supply voltage binary output	6 V
Output current binary output	2 mA
Binary output wire breakage detection	I < 30 µA in ON state R > 800 ohm in OFF state
Binary output short-circuit detection	I < 500 mA in ON state R > 25 ohm in OFF state

Device Specific Data

Signal type	Input Output
Diagnostics message module	OFF ON
Signal type	NAMUR proximity switch/contact; 3-conductor PNP proximity switch; output
Inverting input/output	Normal inverted
Line fault monitoring	OFF ON
Behaviour in case of binary signal error	Replacement value "0" Replacement value "1" Hold (initial value 0) Hold (initial value 1)

Remote I/O

IS1+ Remote I/O Digital input-output module

For Zone 2 Ex n

9471/35-16-11 Art. No. 230225



Device Specific Data

Counter/frequency operating mode	32-bit up/down counter 16-bit up/down counter 16-bit counter 1 Hz to 3 kHz 1 Hz to 20 kHz with direction 1 Hz to 20 kHz 0.1 to 600 Hz
Counter control	Stop Run Reset
Count	Positive slope Negative slope
Signal settings note	Settings are configured in pairs
LED module requires maintenance	"M/S" LED, blue
LED operating conditions	"RUN" LED, green
LED channel error	LED for each channel, red
LED channel status	LED per channel, yellow
Retrievable parameters	Serial number Software revision Type Manufacturer Hardware revision
Module status and alarms	Internal bus error primer / redundant No response from IOM Configuration does not correspond to the module Hardware error Excess temperature Slot error Module requires maintenance
Signal status bit	"1" = Output supplied with power "0" = High-impedance output
Influence of ambient temperature	0,07 % / 10 K
Note	All information in % of the signal span at 23 °C

Diagnostics

LED group error	"ERR" LED, red
-----------------	----------------

Ambient Conditions

Ambient temperature °C	-40°C ... +75°C
Ambient temperature °F	-40°F ... +167°F
Storage temperature °C	-40°C ... +80°C
Storage temperature °F	-40°F ... +176°F
Max. operating altitude	< 2000 m
Max. relative humidity	95% (without condensation)
Shock (semi-sinusoidal)	(IEC EN 60068-2-27) 15 g (3 shocks per axis and direction)
Vibration (sinusoidal)	(IEC EN 60068-2-6) Frequency range 2 ... 13.2 Hz Amplitude 1 mm (peak value) Frequency range 13.2 ... 100 Hz Acceleration amplitude 0.7 g
Electromagnetic compatibility	Tested to the following standards and regulations: EN 61326-1 (2006) IEC 61000-4-1 to 61000-4-6, NAMUR NE 21

Remote I/O

IS1+ Remote I/O Digital input-output module

For Zone 2 Ex n

9471/35-16-11 Art. No. 230225



Ambient Conditions

Note	(observe operating instructions)
------	----------------------------------

Mechanical Data

Degree of protection (IP) (IEC 60529)	IP20
Module enclosure	Polyamide 6GF
Fire resistance (UL 94)	V2
Pollutant class	Corresponds to G3
Width	96.5 mm
Width, inches	3.8 in
Height	67 mm
Length	128 mm
Length, inches	5.04 in
Mounting depth, inches	2.64 in
Weight	275 g
Weight	0.61 lb

Mounting / Installation

Mounting orientation	Horizontal Vertical
----------------------	------------------------

Technical Drawings – Subject to Alterations

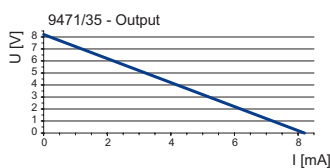

Output characteristic

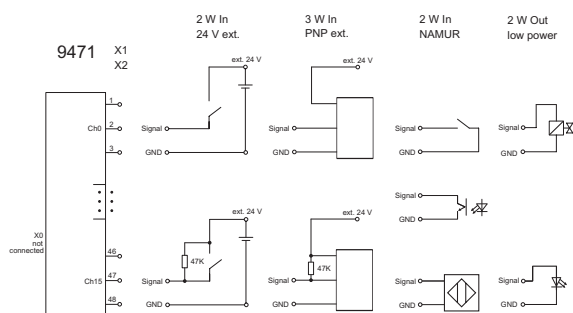
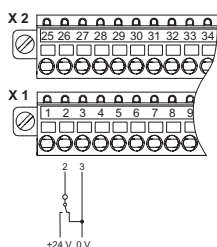

9471/35 connection diagram

Remote I/O

IS1+ Remote I/O Digital input-output module

For Zone 2 Ex n





9471/35-16-11 Art. No. 230225

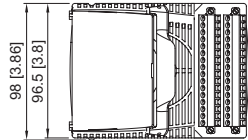
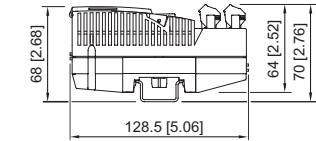

Dimensional Drawings (All Dimensions in mm [inches]) – Subject to Alterations

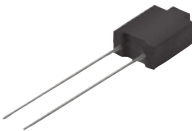

Accessories

		Art. No.
Termination board 9491		
	The termination boards are used for parallel switching of the inputs and outputs of two I/O modules for signal redundancy. Signal redundancy for I/O modules 9471/35 and 9472/35 from firmware 04-xx	273019
Pluggable terminal		
	1.5 mm ² with lock, 24-pin, spring clamp connection, black, for connecting the field signals to I/O modules, for non-intrinsically safe field circuits Version: Only for 9469, 9471 and 9472 I/O modules Labelling: 1 to 24	245090
	1.5 mm ² with lock, 24-pin, spring clamp connection, black, for connecting the field signals to I/O modules, for non-intrinsically safe field circuits Version: Only for 9469, 9471 and 9472 I/O modules Labelling: 25 to 48	245091
Resistor error message suppression		
	The resistors are used to suppress error messages for unused I/O channels Resistance value: 5K6/0.5 W Suitable for: AIM 9468; UMH 9469; DIOM 9470; DIOM 9471; DIOM 9472; DOM 9475 For intrinsically safe circuits (simple apparatus according to EN 60079-11)	244911
Partition		
	For mounting between intrinsically safe and non-intrinsically safe connections between I/O modules to maintain a tight string length of 50 mm	220101
Warning label		
	"Clean modules only with a damp cloth."	162796

Remote I/O

IS1+ Remote I/O Digital input-output module

For Zone 2 Ex n

9471/35-16-11 Art. No. 230225



DIN A4 sheet

Art. No.



For label plate on I/O modules; 6 plates per sheet;
IS Wizard printout; packaging unit = 20 sheets

162832

Labelling strips

Art. No.

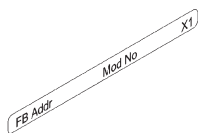

"FB Addr ... Mod No ..." for pluggable terminal, 26 pieces on the sheet

162788

Vibration bracket set

Art. No.



When installed in environments with extreme vibration (> 0.7 g and max. 4 g), the 9490 vibration brackets may be used as an additional measure and provide mechanical stability for the individual modules.

For mounting: All I/O modules, except 9477/12 and 9478

Number of brackets in a set: 8

Screws (item no. 275516) must be ordered separately.

271920

Set of screws

Art. No.

Set of M5 x 14 screws (self-tapping) for 9490 vibration brackets

Number of screws in a set: 25

275516

We reserve the right to make alterations to the technical data, dimensions, weights, designs and products available without notice. The illustrations cannot be considered binding.