

Remote I/O

IS1+ Remote I/O 24 V digital in/output module

For Zone 2 Ex n

9472/35-16-12 Art. No. 230239



- Sixteen channels can be used in pairs as inputs or outputs (24 V / 0.5 A)
- Inputs/outputs Ex ec with line fault monitoring and LED error and status indication for each channel plus SIL 2 shutdown input
- Module in Zone 2, Cl. I, Div. 2 can be hot swapped

MY R. STAHL 9472A



The 9472/35 24 V series digital input/output module for Zone 2, Cl. I, Div. 2 has 16 channels, which can be used in pairs for operation as inputs for contacts and PNP or NAMUR proximity sensors (EN 60947-5-6) or as outputs for solenoid valves up to 24 V/0.5 A. Eight inputs can be used for frequencies of up to 20 kHz, and four can be used for detecting the direction of rotation. All inputs/outputs are short-circuit proof and galvanically separated from the system. Additional control input for "Plant STOP" (IEC61508 / through SIL2)

Technical Data

Explosion Protection	
Application range (Zones)	2
Ex interface zone	2
IECEX gas certificate	IECEX DEK 16.0010X
IECEX gas explosion protection	Ex ec ic [ia Ga] IIC T4 Gc
ATEX gas certificate	DEKRA 16 ATEX 0016 X
ATEX gas explosion protection	Ex II 3 (1) G Ex ec ic [ia Ga] IIC T4 Gc
FMus certificate	FM17US0332X
cFM certificate	FM16CA0134X
Marking cFMus	NI, Class I, Div. 2, Groups A,B,C,D; Class I, Zone 2, AEx/Ex ec ic Group IIC T4 Gc Ta = -40°C ... +75°C See Doc. 9472 6 031 001 1
Certificates	ATEX (DEK), Canada (FM), China (NEPSI), IECEX (DEK), India (PESO), Korea (KTL), SIL (exida), USA (FM)
Ship approval	ABS, BVIS, EU RO MR (DNV), KR, LR
Declaration of Conformity	ATEX (EUK), China (CCC)
Installation	Zone 2, Cl. I, Div. 2 and safe area
Further information	see respective certificate and operating instructions
Electrical Data	
Number of channels	(adjustable parameters in pairs) 16 Ex ec inputs/outputs
Max. number of NAMUR inputs	16 (channels 0 to 15)
Max. number of 3-conductor PNP inputs	16 (channels 0 ... 15)
Max. number of binary outputs	16 (channels 0 to 15)
External supply voltage U_H (X0)	18 to 32 V DC (nominal voltage 24 V)
Max. current consumption (X0)	16 x 0.5 A (depends on the total current of the binary outputs)

Remote I/O

IS1+ Remote I/O 24 V digital in/output module

For Zone 2 Ex n

9472/35-16-12 Art. No. 230239



Electrical Data

Control input suitability (X0)	Shutdown up to SIL 2, low demand (IEC 61508)
Control input function (X0)	"Plant STOP" for switching off all outputs
Control input output voltage (X0)	9.7 V to 14 V without load (with external supply 18 to 32 V DC)
Control input short-circuit current (X0)	0.36 – 0.65 mA
Control input normal operation (X0)	$U > 6 \text{ V}$ (terminals X0.3 und X0.4 bridged)
Control input outputs OFF (X0)	$U < 2 \text{ V}$ (terminals X0.3 and X0.4 interrupted)
Connection Ex ec/nA field signals (X1 and X2)	2 pluggable, black terminals, 24-pin, 1.5 mm ² , push-in design with lock (must be ordered separately) Single-wire connection - rigid 0.08 to 1.5 mm ² (AWG 28 to 16) - flexible with core end sleeves (without plastic sleeve) 0.25 to 1.5 mm ² - flexible with core end sleeves (with plastic sleeve) 0.25 to 0.5 mm ² - Stripping length min. 9 mm
Connection external supply and "System OFF"	Plug-in, black terminals, 4-pin, 1.5 mm ² , screw terminal design with lock (included) Single-wire connection - rigid 0.08 to 1.5 mm ₂ (AWG 28 to 16) - flexible with core end sleeves (without plastic sleeve) 0.25 to 1.5 mm ₂ - flexible with core end sleeves (with plastic sleeve) 0.25 to 0.5 mm ₂ - Tightening torque 0.5 to 0.6 Nm - Stripping length min. 7 mm Dual-wire connection - rigid 0.08 to 1.5 mm ₂ (AWG 28 to 16) - flexible with core end sleeves (without plastic sleeve) 0.25 to 1.5 mm ₂ - flexible with core end sleeves (with plastic sleeve) 0.25 to 0.5 mm ₂ - Tightening torque 0.5 to 0.6 Nm - Stripping length min. 7 mm

Auxiliary Power

Power supply connection	BusRail types 9494
Auxiliary power version	Intrinsically safe Ex ia via BusRail
Behaviour during undervoltage	All outputs "OFF"
Current consumption	90 mA
Max. power consumption	2.2 W
Max. power dissipation	Output: 5.4 W Input: 1.4 W

Galvanic Isolation

Test voltage for galvanic separation	Acc. to standard EN 60079-11
Auxiliary power/system components	$\geq 1800 \text{ V AC}$
I/O channels/system components	$\geq 1800 \text{ V AC}$
I/O channels / ground (PA)	$\geq 1800 \text{ V AC}$

Input

Max. number of counter inputs	8 (channel 8 to 15)
Max. number of frequency inputs	8 (channel 8 to 15)
Binary input 1 signal type	2-conductor 24 V contacts 3-conductor PNP initiators
Min. binary input signal 1 ON	$> 60\% U_H$ supply voltage
Max. binary input signal 1 OFF	$< 55\% U_H$ supply voltage
Binary input 1 switching hysteresis	$5\% U_H$ supply voltage
Binary input 1 internal resistance	11 k Ω
Binary input 1 wire breakage detection	Input signal $\leq 1.6 \text{ V}$

Remote I/O

IS1+ Remote I/O 24 V digital in/output module

For Zone 2 Ex n

9472/35-16-12 Art. No. 230239



Input

Binary input 1 short-circuit detection	Input signal ≤ 1.6 V				
Binary input 2 signal type	NAMUR initiators (IEC 60947)				
Min. binary input signal 2 ON	> 2.1 mA				
Max. binary input signal 2 OFF	< 1.2 mA				
Binary input 2 operating point	1.65 mA				
Binary input 2 switching hysteresis	≥ 0.2 mA				
Binary input 2 supply voltage	8 V \pm 5%				
Binary input 2 internal resistance	1 k Ω				
Binary input 2 wire breakage detection	$I < 100$ μ A				
Binary input 2 short-circuit detection	$R < 100$ ohms				
Binary input 3 signal type	Frequency input				
Max. switching frequency binary input 3	NAMUR signal: 20 kHz (at frequencies > 1 kHz, the maximum conductor length is reduced, e.g. at 5 kHz to approx. 75 m) 3-conductor PNP proximity switches and 2-conductor 24 V contacts: ≤ 300 Hz (20 kHz only with push-pull encoder) Note: The inputs must be switched to +24 V and 0 V (see technical drawings).				
Binary input 3 min. pulse width	25 μ s				
Binary input 4 signal type	Counter input				
Binary input 4 counting range	0 ... 65535				
Binary input 4 function	Forwards/backwards counter Frequency with direction				
Binary input 4 resolution	16 (unece.unit.BIT) 32 (unece.unit.BIT)				
Measuring range of binary input 3		0.1 to 600 Hz	1 Hz to 3 kHz*	1 Hz to 20 kHz	
	Measurement discrimination	0.01 Hz	0.05 Hz	0.5 Hz	
	Accuracy	0.1%	0.1%	0.1%	
		* Default			
Max. delay of binary input 3	Filter (adjustable parameters)	None	Small	Medium	Large
	Frequency				
	$0.1 \text{ Hz} \leq f < 1 \text{ Hz}$	$1/f + 1 \text{ ms}$	$2/f$	$3/f$	$6/f$
	$1 \text{ Hz} \leq f < 10 \text{ Hz}$	$1/f + 1 \text{ ms}$	$4/f$	$9/f$	$18/f$
	$10 \text{ Hz} \leq f < 100 \text{ Hz}$	$1/f + 1 \text{ ms}$	$8/f$	$27/f$	$54/f$
	$100 \text{ Hz} \leq f < 1 \text{ kHz}$	$1/f + 1 \text{ ms}$	$16/f$	$81/f$	$162/f$
	$1 \text{ kHz} \leq f < 1960 \text{ Hz}$	1.5 ms	$32/f$	$243/f$	$486/f$
	$1960 \text{ Hz} \leq f < 10 \text{ kHz}$	1.5 ms	16.5 ms	124 ms	248 ms
	$10 \text{ kHz} \leq f < 20 \text{ kHz}$	1.5 ms	33 ms	372 ms	744 ms
$f \geq 20 \text{ kHz}$	1.5 ms	66 ms	372 ms	744 ms	

Output

Signal type binary output	2-conductor (24 V/0.5 A)
Supply voltage binary output	Corresponds to the ext. supply voltage $U_H - 0.7$ V (X0)
Output current binary output	30 mA to 0.5 A per channel (electronically limited)
Binary output connectable loads	Resistive Inductive Capacitive
Max. switchable inductance binary output	< 0.5 H per channel (ext. freewheeling diode parallel to the load recommended)

Remote I/O

IS1+ Remote I/O 24 V digital in/output module

For Zone 2 Ex n

9472/35-16-12 Art. No. 230239



Output

Binary output wire breakage detection	R > 800 ohm in OFF state I < 30 mA in ON state
Binary output short-circuit detection	I < 500 mA in ON state R > 25 ohm in OFF state

Device Specific Data

Signal type	Input Output
Diagnostics message module	ON OFF
Inverting input/output	Normal inverted
Line fault monitoring	ON OFF
Behaviour in case of binary signal error	Replacement value "0" Replacement value "1" Hold (initial value 0) Hold (initial value 1)
Counter/frequency operating mode	32-bit up/down counter 16-bit up/down counter 16-bit counter 1 Hz to 3 kHz 1 Hz to 20 kHz with direction 1 Hz to 20 kHz 0.1 to 600 Hz
Counter control	Stop Run Reset
Count	Positive slope Negative slope
Signal settings note	Settings are configured in pairs
LED module requires maintenance	"M/S" LED, blue
LED operating conditions	"RUN" LED, green
LED channel error	LED for each channel, red
LED channel status	LED per channel, yellow
24 V external power supply LED	"24 V" LED, green
"Plant STOP" LED	"24 V" LED, yellow
Retrievable parameters	Hardware revision Manufacturer Serial number Software revision Type
Module status and alarms	Internal bus error primer / redundant No response from IOM Configuration does not correspond to the module Hardware error Excess temperature Slot error Module requires maintenance
Signal status bit	"1" = Output supplied with power "0" = High-impedance output

Remote I/O

IS1+ Remote I/O 24 V digital in/output module

For Zone 2 Ex n

9472/35-16-12 Art. No. 230239



Device Specific Data

Influence of ambient temperature	0,07 % / 10 K
Note	All information in % of the signal span at 23 °C

Diagnostics

LED group error	"ERR" LED, red
-----------------	----------------

Ambient Conditions

Ambient temperature °C	-40°C ... +75°C
Ambient temperature °F	-40°F ... +167°F
Ambient temperature note	+75 °C (+167 °F) if the total current of the outputs is ≤ 4 A +65 °C (+149 °F) if the total current of the outputs is ≤ 8 A
Storage temperature °C	-40°C ... +80°C
Storage temperature °F	-40°F ... +176°F
Max. operating altitude	< 2000 m
Max. relative humidity	95% (without condensation)
Shock (semi-sinusoidal)	(IEC EN 60068-2-27) 15 g (3 shocks per axis and direction)
Vibration (sinusoidal)	(IEC EN 60068-2-6) Frequency range 2 ... 13.2 Hz Amplitude 1 mm (peak value) Frequency range 13.2 ... 100 Hz Acceleration amplitude 0.7 g
Electromagnetic compatibility	Tested to the following standards and regulations: EN 61326-1 (2006) IEC 61000-4-1 to 61000-4-6, NAMUR NE 21
Note	(observe operating instructions)

Mechanical Data

Degree of protection (IP) (IEC 60529)	IP20
Module enclosure	Polyamide 6GF
Fire resistance (UL 94)	V2
Pollutant class	Corresponds to G3
Width	96.5 mm
Width, inches	3.8 in
Height	67 mm
Length	128 mm
Length, inches	5.04 in
Mounting depth, inches	2.64 in
Weight	275 g
Weight	0.61 lb

Mounting / Installation

Mounting orientation	Horizontal Vertical
----------------------	------------------------

Remote I/O

IS1+ Remote I/O 24 V digital in/output module

For Zone 2 Ex n

9472/35-16-12 Art. No. 230239



Technical Drawings – Subject to Alterations

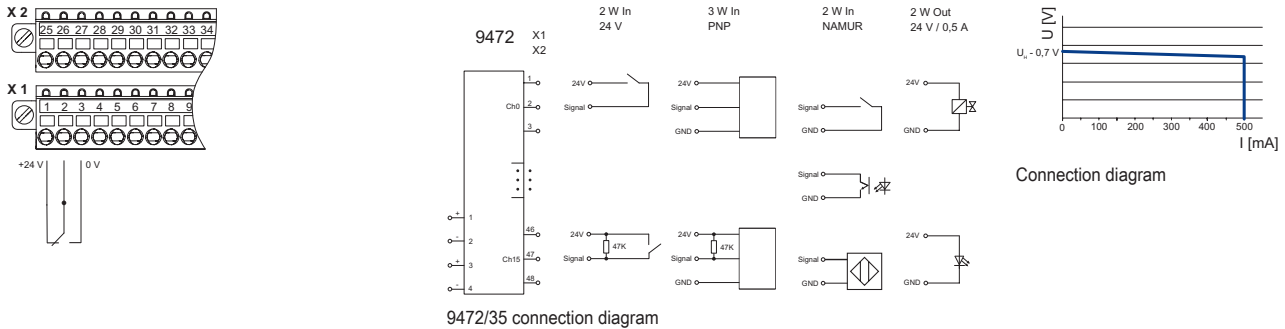

Dimensional Drawings (All Dimensions in mm [inches]) – Subject to Alterations

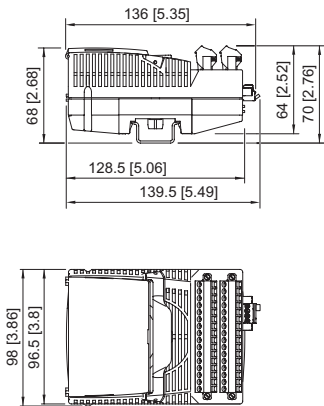

Accessories

Termination board 9491



The termination boards are used for parallel switching of the inputs and outputs of two I/O modules for signal redundancy.
Signal redundancy for I/O modules 9471/35 and 9472/35 from firmware 04-xx

Art. No.

273019

Ex i/Ex e relay module for Zone 1



The Ex i/Ex e relay module is used for the galvanically isolated switching of intrinsically safe (Ex i) and non-Ex i (Ex e) electrical circuits.
Coil circuit: Ex i or non-Ex i (Ex e)
Contact circuit: Ex i or non-Ex i (Ex e)
Thanks to the integrated safeguarding for the contact and coil circuit, additional safeguarding is not necessary.

Note: no usable with 9475/32-04-12, 9475/32-08-52, 9475/33-08-50

Art. No.

273000

Electronic relay



The electronic relay modules are used to switch Ex e loads using an intrinsically safe (Ex i) or non-intrinsically safe (Ex e) control system.

Coil circuit: Ex i or non-Ex i (Ex e)*

Contact circuit: Non-Ex i (Ex e)

*It is possible to switch between Ex i and non-Ex i circuits, or vice versa, at any time without restriction.

Note: Cannot be used with 9475/32-04-12, 9475/32-08-52, 9475/33-08-50

Art. No.

282457

Remote I/O

IS1+ Remote I/O 24 V digital in/output module



For Zone 2 Ex n

9472/35-16-12 Art. No. 230239



Pluggable terminal

Art. No.

	1.5 mm ² with lock, 24-pin, spring clamp connection, black, for connecting the field signals to I/O modules, for non-intrinsically safe field circuits Version: Only for 9469, 9471 and 9472 I/O modules Labelling: 1 to 24	245090
	1.5 mm ² with lock, 24-pin, spring clamp connection, black, for connecting the field signals to I/O modules, for non-intrinsically safe field circuits Version: Only for 9469, 9471 and 9472 I/O modules Labelling: 25 to 48	245091

Resistor error message suppression

Art. No.

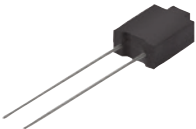
	The resistors are used to suppress error messages for unused I/O channels Resistance value: 5K6/0.5 W Suitable for: AIM 9468; UMH 9469; DIOM 9470; DIOM 9471; DIOM 9472; DOM 9475 For intrinsically safe circuits (simple apparatus according to EN 60079-11)	244911
--	--	--------

Partition

Art. No.

	For mounting between intrinsically safe and non-intrinsically safe connections between I/O modules to maintain a tight string length of 50 mm	220101
---	---	--------

Warning label

Art. No.

	"Clean modules only with a damp cloth."	162796
--	---	--------

DIN A4 sheet

Art. No.

	For label plate on I/O modules; 6 plates per sheet; IS Wizard printout; packaging unit = 20 sheets	162832
--	---	--------

Labelling strips

Art. No.

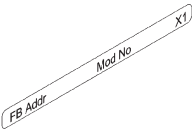
	"FB Addr ... Mod No ..." for pluggable terminal, 26 pieces on the sheet	162788
--	---	--------

Vibration bracket set

Art. No.

	When installed in environments with extreme vibration (> 0.7 g and max. 4 g), the 9490 vibration brackets may be used as an additional measure and provide mechanical stability for the individual modules. For mounting: All I/O modules, except 9477/12 and 9478 Number of brackets in a set: 8 Screws (item no. 275516) must be ordered separately.	271920
--	---	--------

Set of screws

Art. No.

	Set of M5 x 14 screws (self-tapping) for 9490 vibration brackets Number of screws in a set: 25	275516
--	---	--------

Remote I/O

IS1+ Remote I/O 24 V digital in/output module

For Zone 2 Ex n

9472/35-16-12 Art. No. 230239



We reserve the right to make alterations to the technical data, dimensions, weights, designs and products available without notice. The illustrations cannot be considered binding.